

Humidifier WDH-SE2303

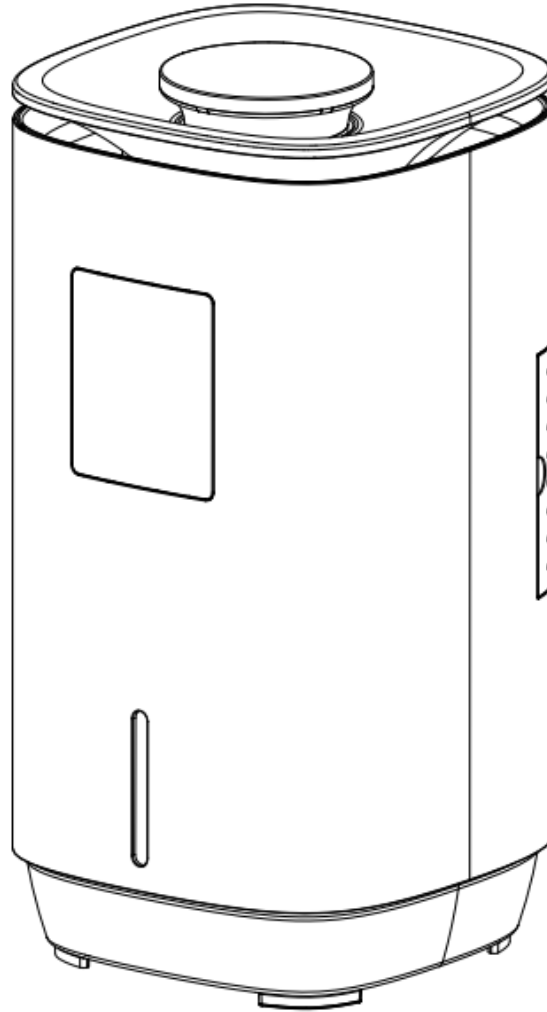

Dear customer,

You have chosen a high-quality product. Here are a few tips to help you enjoy this product:

In the event of problems

We hope that the appliance meets your expectations! Should there be any cause for complaint despite the greatest possible care, please contact us briefly, as we are very concerned about your satisfaction and would like to clear up any misunderstanding.

The first launch

As the inner units come into contact with water for the first time, there may be a slight odor at the beginning. This initial odor disappears after a very short time (1-2 days).

Only use clear and clean (or distilled) water below 40°C and no flavorings etc. to fill the humidifier.

Important safety instructions

- Supervise the humidifier when children are near the appliance!
- If unusual odors or noises occur during the work process, disconnect the mains plug from the socket immediately!
- Pay attention to the electricity: Never walk into the appliance with objects or insert them!
- Disconnect the mains plug before moving or cleaning the appliance!
- Do not block the outlet for the steam and please ensure that there is sufficient space/clearance around the appliance!
- Only qualified personnel or electricians are permitted to open the device!
- Make sure that no moisture reaches the electrical system of the appliance!
- Make sure that the power cable is unfolded (untied) before you connect it to the socket!
- Make sure that the plug is clean and properly connected to the socket before using the appliance!
- Never touch the plug or socket with wet hands!
- Do not repair defective or damaged cables on the appliance yourself, you could get a serious electric shock!
- Ensure that flammable substances (e.g. gases/oils etc.) are never in the vicinity of the appliance!
- If you are not going to use the appliance for a longer period of time, switch it off and unplug it from the mains!
- Do not start the appliance without water in the water tank!
- Do not use the appliance in bathrooms or other places with very high humidity.
- Do not add any additives such as scented oils to the water!
- Use at freezing temperatures can lead to damage or defects in the humidifier!
- Do not disconnect the mains plug by pulling on the power cable!
- Do not use insect repellent, oil or paint spray etc. near the humidifier. This can damage the appliance or even cause a fire!
- Do not place the appliance on a sloping or uneven surface!
- Please do not expose the mains plug and socket to direct moisture and steam. Use the cable length of the appliance so that the mains plug and socket outlet are not directly next to the humidifier!
- For effective and economical humidification operation, please close all doors and windows in the room where the humidifier is located!
- Always set up and transport the appliance in its correct and upright position!
- Switch the humidifier off completely at the main switch when refilling and for cleaning!
- Do not move the appliance with a full water tank!
- Never repair/dismantle the base board on the main body without authorization!
- Do not cover the air outlet and the air inlet grille!
- This product may only be operated and used by children aged 8 years and over. Children with sensory impairments, mental disorders or a lack of relevant knowledge and experience must not use this product without a supervisor/authorized person!
- Children must be properly supervised and instructed when cleaning and maintaining this product!
- Do not allow children to play with the appliance!
- Only use the appliance indoors, never outdoors!
- This product contains a UV lamp module. If the UV protection shield is damaged due to improper use, UV rays may escape. A small amount of UV radiation can cause damage to the eyes and skin. If the device is obviously damaged and can no longer be switched on and used, please contact the manufacturer. The UV lamps must be replaced by the manufacturer of the device or a designated service center.
- Never replace the mains plug without authorization ! If the mains plug is damaged, contact the designated customer service center !

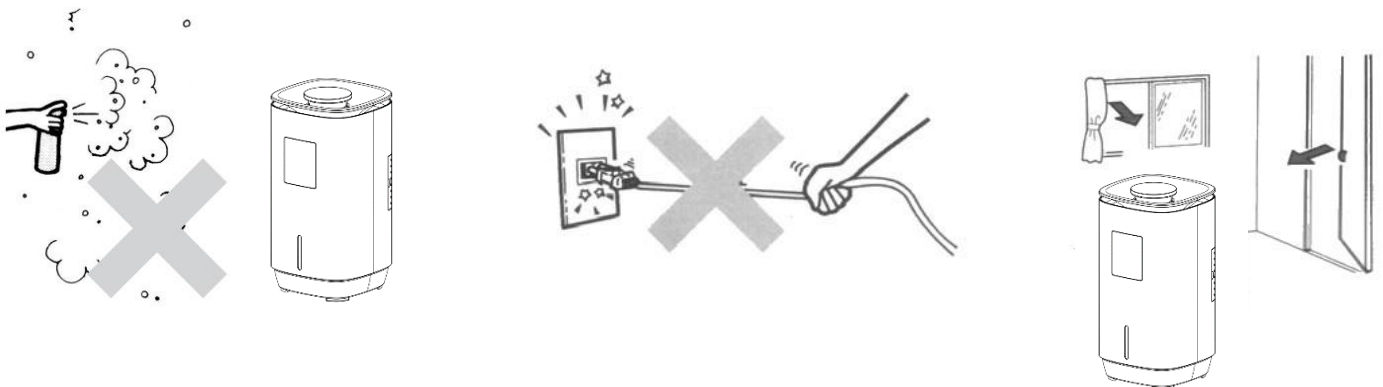

Note: Please switch off the appliance immediately and disconnect it from the mains/power supply if something seems to be wrong! In this case, please contact a specialist and do not attempt to repair the appliance yourself!

Further information:

- Please note that high humidity can lead to the growth of biological organisms such as bacteria in the environment.
- Make sure that the ambient humidity is not too high. If the ambient humidity is too high, please set the humidifier to a lower level to reduce humidification. If you still want to use the humidifier despite the high humidity in the environment, please use it intermittently.
- Make sure that absorbent materials such as carpets, curtains, drapes or tablecloths do not get wet!
- If you are not using the humidifier, remove the water from the tank!
- If you want to store the humidifier, remove the water from the tank and clean the appliance!
- If the humidifier has not been used for a long time, clean it before the next use!
- **Warning:** Microorganisms can form in the water in the environment in which the humidifier is used or stored. If the water is not changed frequently or the tank is not cleaned every 3 days, these microbes can grow in the tank and be released into the air, which can lead to serious health problems!
- Empty the water tank and change the water every 3 days.
- Before refilling, clean the water tank under running tap water or with a cleaning agent to remove dust, deposits or films that have formed on the sides or inside the tank. Then wipe all surfaces dry!

Device description:

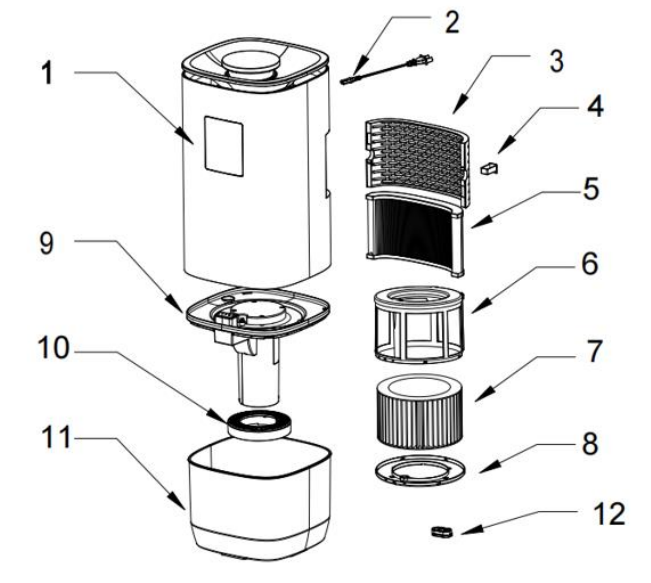

- | | |
|--------------------------|------------------------------|
| 1. Display/control panel | 7. Evaporation filter |
| 2. Power cable | 8. Filter holder - bottom |
| 3. Air intake | 9. Water tank partition wall |
| 4. Aroma box | 10. Water filter |
| 5. HEPA filter | 11. Water tank |
| 6. Filter holder - top | 12. Silver ion element |

Functions and features:

1. Evaporative humidifier with cool and warm humidity output
2. Four-stage adjustment of the humidification performance
3. Setting the device runtime up to 12 hours
4. adjustable hygrostat with air humidification from 40 % to 80 % r.h.
5. High level of convenience thanks to auto mode
6. Sleep mode: LED lights do not disturb your sleep
7. Health mode: The humidifier automatically adjusts the relative humidity to a range between 46 % and 50 %.
8. Drying function to prevent mold growth on the water filter
9. with optional aroma function
10. the UV lamp kills 99.95% of bacteria with high efficiency
11. automatic switch-off protection when the water tank lid is removed
12. Water tank light indicates the humidity level by its color (< 30 %: red, 30 % <> 60 %: cold white, >= 60 %: blue)
13. automatic switch-off protection with warning if no water is present
14. silver ions for disinfection
15. Built-in H13 HEPA filter with 99.95 % filtration efficiency
16. Non-immersive evaporation filter with 99 % bactericidal efficiency
17. humidifier and air purifier in one device for the best air quality
18. Waterproof LED display
19. Automatic cleaning at the touch of a button

1. Before use

- 1.1. The humidifier is intended for use in rooms with an ambient temperature of 0° - 50°C and a relative humidity of less than 85%.
- 1.2. Only use clean water with a temperature of less than 40°C.
- 1.3. If the humidifier is not used for a long time, please clean the water tank before not using it/putting it out of operation.

2. Display



The digital display shows the current ambient humidity.

2.1 Power button:



When the device is switched on in standard mode, the humidifier starts at level 2, the UV and negative ion functions are inactive.

2.2 Drying mode:

The drying function is automatically activated when the appliance is switched off using the power button. The display shows the symbol . The drying mode runs for 50 minutes, then the appliance automatically switches to stand-by mode. The drying function can be canceled by pressing the power button again.

2.3 UV button/negative ion button:



Press the button for 2 seconds to activate the **negative ions** function. To deactivate it again, press the button again for 2 seconds. Press the button briefly to activate the **UV function**. Press the button again briefly to deactivate the function. Both functions can be combined with each other.

2.4 Fog intensity button:



When switched on, the device starts at fan level 2. If you press the mist level button again, the humidifier operates at level 3. If you press the button again, the humidifier operates at level 4 and so on.

The display then looks as follows:



2.5 Humidity button:



a) Without preset humidity:

When the "--- %" button is pressed for the first time, no target humidity is set. By pressing it again, you can set the target humidity, starting at 40 %. The target humidity can be increased in 5 % increments up to a maximum of 80 %. Pressing again takes you to the non-preset target humidity mode. The humidifier then continues to operate at the fan level that was active before the target humidity was set.

b) With preset humidity:

Press the button again to display the humidity you have set.

Each time this button is pressed, the humidity increases by 5% RH until 80% RH is reached. If you press the button again, you return to the non-preset humidity mode.

Once the setting has been completed, the screen flashes three times with the currently set value and the current room humidity is displayed. (The displayed humidity is shown in a range between 20-90 %).

In the first 2 minutes after setting the target humidity, the appliance continues to run unchanged at the set level.

After 2 minutes, the fan operates automatically according to the following settings:

- If the humidity in the room has reached or exceeded the set humidity value, the humidifier operates at level 1.
- If the displayed value is 2% lower than the set humidity value, the humidifier is operating at level 2.
- If the displayed value is 4% lower than the set humidity value, the humidifier is operating at level 3.
- If the displayed value is 6% lower than the set humidity value, the humidifier is operating at level 4.

Note: If you change the fan speed during operation with a preset target humidity, the humidifier continues to run at the selected fan speed for 2 minutes and then performs the adjustment described above again after 2 minutes.

Note: The device updates the displayed ambient humidity value every 10 seconds.

2.6 Mode button:



The device has 3 modes:

a) Auto mode:

AUTO

b) Health mode:



c) Sleep mode:



- If the device is switched on and no mode has yet been set, the three symbols shown above do not light up.
- When you press the mode button for the first time, the **Auto mode** symbol flashes and the device switches to Auto mode.
- If you press the mode button for the second time, the symbol for **Health mode** flashes and the device switches to health mode.
- If you press the mode button a third time, the symbol for **Sleep mode** flashes and the device switches to sleep mode.
- If you press this button for the fourth time, the humidifier returns to the default setting without mode.

Note: The mode is permanently set when the corresponding light has flashed three times.

a) Auto mode:

The fan speed is automatically set and adjusted according to the following table:

< 35 % r.h.	→ Device runs at level 3
36 % r.h. <> 45 % r.h.	→ Device runs at level 2
46 % r.h. <> 59 % r.h.	→ Device runs at level 1
>= 60 % r.h.	→ Device runs at level 1

b) Health mode:

The device starts at level 3, the UV function is activated and the negative ion function is deactivated.

In health mode, the aim is to achieve a relative humidity of between 46 % and 50 %. The fan level is set automatically based on the following criteria:

< 46 % r.h.	→ Device runs at level 3
>= 50 % r.h.	→ Device runs at level 1

c) Sleep mode / night mode:

If you press the mode button for the third time, the "Sleep mode" symbol flashes three times. After the symbol for sleep mode has stopped flashing, the device goes into sleep mode; the sleep mode symbol is shown on the display.

- Functions that were switched on before the device went into sleep mode (including UV function, time measurement and negative ions) are not affected by sleep mode. However, the heating function will be switched off.
- The humidifier operates in sleep mode at level 1.
- After 10 seconds, all symbols on the display except the sleep mode symbol go out. The light for the water tank is also switched off.
- Press any button to exit sleep mode. The device then returns to the operating status before switching to sleep mode.
- If the appliance detects a lack of water in sleep mode, the low water symbol lights up red, but the water tank light remains switched off and the signal tone does not sound.

2.7 Timer button:





The running time of the appliance can be set using the timer function (range: 01 - 12 hours running time).

- When the timer button is pressed for the first time, the display shows 01h.
- When you press the button for the second time, the display shows 02h.
- If you press the button twelve times, the display shows 12h.
- If you press the button thirteen times, the display shows 00h.
- Press the button again to repeat the above actions to set the desired running time of the appliance.
- The timer setting is complete when the timer symbol has flashed three times. The "H" symbol appears on the display next to the humidity display.
- The time unit is measured in hours. If less than 1.5 hours remain, 01h is shown on the display. If 1.5 to 2.4 hours remain, the display shows 02h rounded up, etc.
- Press and hold the timer button for 2 seconds to cancel the timer function. The "H" symbol shown in the display next to the humidity display goes out on the display.
- After the timer has expired, the appliance goes into standby mode.

2.8 Heating function / cleaning button:



Press briefly once to activate the heating function for warm moisture output. The heating symbol  is activated on the display. The device operates at level 4. Briefly pressing the button again deactivates the heating function and the humidifier continues to operate at level 3.

Pressing and holding the button (2 seconds) switches the appliance to cleaning mode . The cleaning symbol appears on the display, the water pump continues to work, the water tank light lights up red for 5 seconds and then switches off, the fan stops rotating and all other functions are deactivated.

After 20 minutes, cleaning mode ends and the appliance automatically switches to auto mode.

If you press the power button in cleaning mode, the appliance switches to drying mode and then to standby mode. All other buttons are inactive in cleaning mode.

2.9 WiFi function/childproofing:



WiFi function: After briefly pressing the WiFi button once, the WiFi light starts to flash every 2 seconds. The device switches to WiFi pairing status. Once the device has been successfully paired, the WiFi symbol lights up continuously.

Child lock: Press and hold the WiFi function/child lock button to activate the child lock, press and hold the WiFi function/child lock button again to deactivate the child lock.

If you press any button while the childproof lock is activated, the device buzzer will sound three times and the WiFi function/childproof lock symbol will also flash three times.

2.10 Remote control:

All functions and settings as described in the symbols above can also be operated/set using the remote control supplied. A CR2025 button cell (3V) is required to operate the remote control.

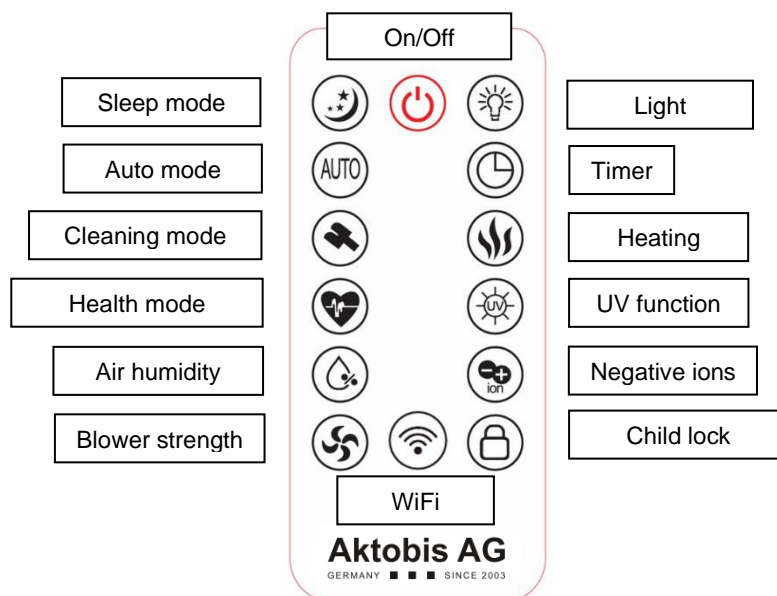

Note: Please note that the water tank light can only be switched on and off using the remote control. The water tank light is activated as standard.

3. Instructions for use

3.1 Fill the water tank up to the indicated marking lines. Place the appliance on a non-slip, smooth and stable surface!

3.2 Insert the mains plug into the socket and the other end into the back of the appliance!

3.3 When the On/Off button is pressed, a signal tone sounds and the appliance switches to standby mode.

3.4 Please follow the operating instructions under point 2.

3.5 If you want to use the aromatherapy function, drizzle a few drops of a water-soluble fragrance onto the felt pad in the aroma box between the air inlet grille/HEPA filter and the appliance in the rear wall. The fragrance is atomized upwards out of the opening and distributed in the room.

Note: If the appliance has not been used for a longer period of time, please clean and dry the felt pad and return it to its original position.

CAUTION: Never use aromatic oils directly in the water tank to avoid damaging the water pump.

3.6 If you would like to use the app control, you must first download the "Tuya Smart" app on your smartphone (tablet) from the app store. After downloading, open the app and make sure that your smartphone is connected to your Wi-Fi network and that the Bluetooth function on your smartphone is switched on. Now follow the instructions in the app to register. After registering, click on "Add device" in the app. Select the "Humidifier (BLE + WiFi)" button under the "Small household appliance" category.

The humidifier

should now be displayed. Click on it to connect it to your smartphone via the app. As soon as your smartphone is paired with the humidifier, the signal light for the WiFi function on the display stops flashing and lights up continuously.

Note: Please note that Wi-Fi mode must be activated in the app for the device to be added.

Now you can conveniently set the humidifier via the app and at the same time read off values such as the current room humidity without having to stand directly in front of the device.

3.7 Indication of water shortage:

The appliance detects a lack of water and switches to low water status.

After the low water symbol  has flashed red three times, the water tank light flashes red for a long time, the buzzer sounds three times per second and the appliance switches off.

"Water level reached" reminder when filling the water tank: When the appliance is in standby or working mode and water is added until it is full, the buzzer sounds 5 times in succession every second and the digital screen flashes 5 times to indicate that the water tank is full and low water mode has ended.

4. cleaning the evaporation filter

Note: In some regions, the water is hard and it is therefore possible for dust and other particles to collect on the evaporation filter after a long period of time.

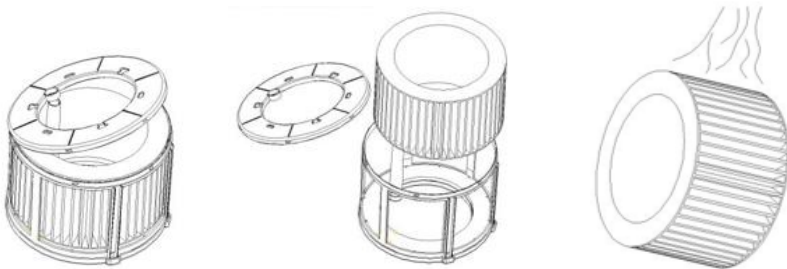

4.1 Remove the cover at the lower end of the filter component and detach the evaporation filter from its holder.

4.2 Gently wash the mesh on the evaporation filter under clean, running water.

4.3 Place the filter back in its intended holder.

4.4 Also wash and dry the five contact points on the surface of the water tank partition.

Note: It is recommended to replace the evaporation filter every six months!

5. Loosening and inserting the water filter for cleaning

Note: Clean the surface of the water filter every week with a soft sponge to remove dust and other dirt particles.

5.1 Remove the water tank partition from the appliance.

5.2 Turn the round element (water filter) clockwise to release it from its holder.

5.3 To reinsert the water filter, bring it into a position in which it slides into the holder.

5.4 Now turn the water filter counterclockwise until it clicks into place.

Note: It is recommended to replace the water filter after three months of continuous use of the appliance!

6. Replacement of the HEPA filter

Note: If the degree of soiling is too high, the humidification quality will be impaired and the noise level will increase during operation.

6.1 Hold the inlets marked with arrows and pull gently on the air inlet grille to remove it from the appliance.

6.2 Press forward on both sides of the rear wall with your thumbs to remove the HEPA filter. It will pop out with two clicking noises (left and right).

6.3 Place the new HEPA filter in its intended position by pressing it into the air inlet grille until it clicks into place again.

Note: It is recommended to replace the HEPA filter component every six months. Depending on the duration of use and the ambient air, the time to replace the HEPA filter may vary. You can monitor the degree of soiling yourself and replace the filter when you feel it is appropriate.

7. Further information

7.1 Wipe the five stainless contact points on the surface of the water tank partition dry before restarting the appliance.

7.2 If you do not use the humidifier for a long time, it is recommended that you first run the drying mode to dry the evaporation filter. The mains plug should then be unplugged so that the remaining water in the tank can be tipped away. Also clean the surface of the water filter with water and then dry it.

7.3 It is recommended to replace the silver ion element every six months.

Technical data

Model designation:	WDH-SE2303
Voltage:	230 V / 50Hz
Max. Power consumption:	230 W
Max. Humidification capacity:	800 ml/h
Water tank capacity:	Approx. 8 liters
Noise level:	min. ≤ 32 dB(A) max. ≤ 55 dB(A)
Electrical protection class:	II
Frequency band:	2.4 GHz (WLAN) with: < 20 dBm transmission power
Dimensions (H/W/D):	260 x 260 x 508 mm
Weight:	5.4 kg
Application range:	0° - 50°C

We reserve the right to deviate from the technical data !

Troubleshooting

Problem	Possible cause	Solution
The blue operating light does not light up	No power supply	Check the mains plug and/or switch on the appliance
The green LED indicator (fog intensity) lights up, but no fog is emitted	No water in the water tank	Fill up the water tank
Abnormal odor	New device	Remove the water tank, open the lid and leave the tank in a cool place for approx. 12 hours
	Dirty water or old water in the water tank	Clean the water tank and then fill it with fresh, clean water
Fog output too low	Appliance, evaporator or water tank is calcified	Clean all components including the evaporator and the water vapor unit
	Water is dirty or has been in the water tank for too long	Clean the water tank and then fill it with fresh water
Abnormal noises	Water in the water tank is running out	Fill up the water tank
	Device stands on uneven ground	Ensure that the humidifier is standing securely
White dust settles near the appliance	Calcareous water	Use soft (distilled) water to fill the appliance!

Miscellaneous

Humidifiers for a better climate and health benefits

Particularly during the heating period, the relative humidity often falls below the recommended range for living and working spaces. This has an unfavorable effect on the well-being and health of people and animals and can also promote respiratory diseases if the indoor air is permanently very dry. A climate that is too dry can also be harmful to furnishings and plants. This effect can be counteracted with our humidifier.

In the field of human medicine, a balanced humidity of the ambient air is recommended. However, especially in closed, poorly ventilated and well-heated rooms, these values are often undercut, which can lead to reduced respiratory performance and impairment of the skin and mucous membranes. This is particularly the case in winter, as the cold outside air then only has a low absolute humidity. It should therefore be humidified with a humidifier after it has warmed up to room temperature so that the relative humidity does not drop too much.

In very cold areas or at cold times of the year or at night, the human body often consumes more fluids, although the opposite should be assumed due to the lack of fluid loss through sweating. This is due to the humidification of the dry inhaled air and the associated loss of water. If the cold outside air is warmed during inhalation, its water vapor capacity increases and thus also lowers the relative humidity. In contrast, the saturation deficit increases and the tendency of the liquid lung tissue water to change into the gaseous aggregate state increases. In summer or when the ambient air is warm, the inhaled air is hardly heated any further and therefore usually retains its high relative humidity. If the additional water loss through sweating is not too great here, the body's water requirement is therefore higher in cold ambient conditions.

Increased humidity is beneficial for breathing, as oxygen then reaches the bloodstream more easily via the alveoli. The skin requires a high level of humidity in order not to dry out, as this is closely linked to skin moisture. Mucous membranes are particularly susceptible to drying out, as they have little protection against evaporation and are dependent on high humidity to maintain their functions. A low level of moisture in the nasal mucosa can result in an increased incidence of nosebleeds. In general, this also weakens the skin's immune defenses (increased risk of colds) and reduces its ability to exchange substances, which particularly affects the oral mucosa. The susceptibility to skin irritation, redness or even skin inflammation is also increased by low humidity.

Source: www.wikipedia.de

Guarantee declaration:

Notwithstanding the statutory warranty claims, the manufacturer grants a warranty in accordance with the laws of your country, but at least 1 year (in Germany 2 years for private individuals). The warranty begins on the date of sale of the device to the end user. The warranty only covers defects that are attributable to material or manufacturing faults.

Warranty repairs may only be carried out by an authorized customer service centre. The original sales receipt (with date of purchase) must be enclosed in order to assert your warranty claim.

Excluded from the guarantee are

- Normal wear and tear
- Improper use, e.g. overloading the appliance or non-approved accessories
- Damage due to external influences, use of force or foreign objects
- Damage caused by non-compliance with the operating instructions, e.g. connection to an incorrect mains voltage or non-compliance with the installation instructions
- Completely or partially dismantled appliances

Conformity:

The humidifier has been tested and it and/or parts of it have been manufactured to the following (safety) standards:

Naturally with CE (EMC + LVD) conformity

CE (LVD) conformity tested according to: EN 60335-1:2012+A11:2014+A13:2017+A1:2019+A14:2019+A2:2019+A15:2021
EN 60335-2-98:2003+A1:2005+A2:2008+A11:2019
EN 62233:2008

CE (EMC) conformity tested according to: EN IEC 55014-1:2021
EN IEC 55014-2:2021
EN IEC 61000-3-2:2019+A1:2021
EN 61000-3-3:2013+A1:2019+A2:2021

RF conformity tested according to: EN IEC 62311:2020
EN 50665:2017
ETSI EN 301 489-1 V2.2.3 (2019-11)
ETSI EN 301 489-17 V3.2.4 (2020-09)
ETSI EN 300 328 V2.2.2 (2019-07)

- Health and safety in accordance with Article 3 (1) a
- electromagnetic compatibility, Article 3 (1) b
- efficient use of the radio spectrum Article 3(2)

Correct disposal of this product



Within the EU, this symbol indicates that this product must not be disposed of with household waste. Old appliances contain valuable recyclable materials that should be recycled. In addition, the environment and human health should not be polluted by uncontrolled waste disposal. Therefore, please dispose of old appliances via suitable collection systems or send the appliance to the place where you purchased it for disposal. They will then recycle the appliance.

We hope you enjoy using this device

Your Aktobis AG

Keep these instructions for use in a safe place!

Note:
